



Swim Happy.™

RESIDENTIAL MANUAL

Clear Comfort's CCW25 Portable Spa & Swim Sanitation

Patented Hydroxyl-Based Advanced Oxidation (AOP)

Installation, Operations & Maintenance Manual

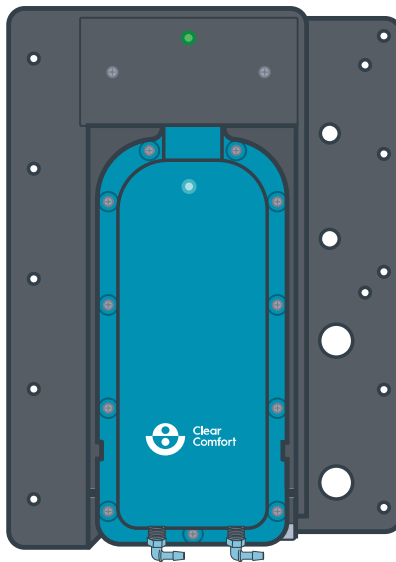

IMPORTANT SAFETY INSTRUCTIONS



For the latest manual
version, scan the QR code or visit:
clearcomfort.com/spa-manual



Clear
Comfort

We're here to help

Have questions? For assistance, contact us:

☎ 303.872.4477

✉ support@clearcomfort.com

🌐 clearcomfort.com/help

For the latest manual
version, scan the QR code or visit:
clearcomfort.com/spa-manual



TABLE OF CONTENTS



WARRANTY: CCW25	2
How to Activate Your Warranty.....	3
GENERAL INFORMATION	4
Important Safety Instructions.....	4
Electrical Safety	5
Grounding	5
General Safety	5
CE Safety Statement	5
Status Light Functionality.....	6
Additional Light Functionality Instructions	7
STANDARD CLEAR COMFORT SYSTEM DESCRIPTION.....	8
Key Features.....	8
Electrical Operating Ranges	8
SYSTEM INSTALLATION: SPAS & SWIM SPAS.....	9
Recommended Materials and Tools.....	9
Equipment List: CCW25	10
CCW25 SPA & SWIM SPA INSTALLATION.....	11
Full System Diagram: CCW25 Install Kit	11
BASIC WATER CARE: SPAS.....	15
SYSTEM MAINTENANCE: CARTRIDGE EXCHANGE	16
How to Exchange Your Cartridge	16
FREQUENTLY ASKED QUESTIONS.....	18
TROUBLESHOOTING	19

WARRANTY: CCW25

Clear Comfort warrants all Equipment to be free from defects in material or workmanship under normal use and service. Clear Comfort, Inc. at its discretion may repair or replace the Equipment or parts thereof. The Company's warranty does not cover any Equipment that has been altered or changed in any way by any person not authorized by Clear Comfort, Inc.

THIS CONSTITUTES THE SOLE WARRANTY MADE BY CLEAR COMFORT, INC. EITHER EXPRESSED OR IMPLIED. THERE ARE NO OTHER WARRANTIES EXPRESSED OR IMPLIED WHICH EXTEND BEYOND THE FACE HEREOF, INCLUDING THE IMPLIED WARRANTIES OF MERCHANTABILITY AND FITNESS FOR A PARTICULAR PURPOSE. IN NO EVENT WILL CLEAR COMFORT, INC. BE LIABLE FOR ANY INCIDENTAL OR CONSEQUENTIAL DAMAGES AND CUSTOMER'S REMEDIES ARE LIMITED TO REPAIR OR REPLACEMENT OF NONCONFORMING CLEAR COMFORT Systems OR PARTS.

This equipment was inspected before shipment from our plant. To original purchasers of this equipment, Clear Comfort Water Inc. ("Clear Comfort"), warrants its Clear Comfort Systems to be free from defects in materials and workmanship for a period of THREE (3) years from the date of purchase. Replacement Cartridges and cylinders are warranted for a period of ONE (1) year from the date of purchase.

Parts which fail or become defective during the warranty period, except as a result of freezing, negligence, improper installation, use, or care, shall be repaired or replaced, at our option, without charge, within 30 days of the receipt of defective product, barring unforeseen delays.

To obtain warranty replacements or repair, defective components or parts should be returned, transportation paid, to the place of purchase, or to the nearest authorized Clear Comfort service center. For further Clear Comfort dealer or service center information, contact Clear Comfort customer service department.

Clear Comfort shall not be responsible for Cartridge, removal and/or re-installation labor or any other such costs incurred in obtaining warranty replacements.

The Clear Comfort Products warranty does not apply to components manufactured

by others. For such products, the warranty established by the respective manufacturer will apply.

This warranty shall be voided if at any time: (i) Customer attempts to make any internal changes to any of the components of the Equipment; (ii) the power supplied to any part of the Equipment exceeds the Equipment's operating parameters; (iii) any external device attached by Customer creates conditions exceeding the Equipment's operating parameters; (iv) the Equipment is tampered with; or (v) the serial number is covered, removed or defaced. Clear Comfort, Inc. reserves the right to seek damages if its system is tampered with, reverse engineered, or if Customer takes any other actions to interfere with the operation or integrity of the Clear Comfort system.

No Other Warranties

To the maximum extent permitted by applicable law, Clear Comfort disclaims all other warranties, either expressed or implied, including, but not limited to, implied warranties of merchantability and fitness for a particular purpose, with regard to the product(s), part(s) and/or any accompanying written materials.

Procedure for Obtaining Performance

In order to obtain the benefits of this warranty, the customer who made the original retail purchase must contact the Clear Comfort Technical Service Department as soon as possible after discovery of the product-related issue, but in no event later than the expiration date of the respective warranty periods provided herein. Upon receipt of this communication, Clear Comfort will promptly notify the customer of the address to which the product may be shipped. The customer shall then ship the product, freight prepaid, to the address indicated, together with a "RETURN GOODS AUTHORIZATION" form obtained from Technical Service and a brief description of the problems encountered. Unauthorized returns will not be accepted. Freight must be prepaid by customer.

Warranties or Representations by Others

No third party has any authority to make any warranties or representation concerning Clear Comfort or its products. Accordingly, Clear Comfort is not responsible for any such warranties or representations.

HOW TO ACTIVATE YOUR WARRANTY

You must activate and validate your warranty within 1 year of your ship date from Clear Comfort either by submitting your warranty card to the address below or by filling out our warranty form online.

Option 1: Mail Your Warranty Card

Address your warranty card to:

Clear Comfort

168 CTC Blvd, Suite E

Louisville, CO 80027

303.872.4477

support@clearcomfort.com



Option 2: Submit Your warranty online

Fill out our warranty form at:

clearcomfort.com/warranty



GENERAL INFORMATION

IMPORTANT SAFETY INSTRUCTIONS

1. READ AND FOLLOW ALL INSTRUCTIONS.

2. For cord connected/convertible units: DANGER – Risk of injury.

- A.** Replace damaged cord immediately.
- B.** Do not bury cord.
- C.** Connect to a grounding type receptacle only.

3. For all permanently connected units intended for use on 15 or 20 ampere, 125V or 230V, single phase branch circuits: WARNING – Risk of Electric Shock. Connect only to a branch circuit protected by a ground-fault circuit-interrupter (GFCI). Contact a qualified electrician if you cannot verify that the circuit is protected by a GFCI.

4. For all cord connected units other than storable pool pumps: WARNING – Risk of Electric Shock. Connect only to a grounding type receptacle protected by a ground-fault circuit interrupter (GFCI). Contact a qualified electrician if you cannot verify that the receptacle is protected by a GFCI.

5. For all permanently connected units: WARNING – Risk of Electric Shock. Connect only to a branch circuit protected by a ground-fault circuit-interrupter (GFCI). Contact a qualified electrician if you cannot verify that the receptacle is protected by a GFCI.

6. For units intended for above-ground storable swimming pools: Do not bury cord. Locate cord to minimize abuse from lawn mowers, hedge trimmers, and other equipment.

7. For all cord and plug connected units: WARNING – To reduce the risk of electric shock, replace damaged cord immediately.

8. For units intended for above ground storable swimming pools: WARNING – To reduce the risk of electric shock, do not use extension cord to connect unit to electric supply; provide a properly located outlet.

9. CAUTION: At low or no flow conditions, gas may accumulate – ensure system is off when backwashing or when water is not being treated to prevent an unsafe gas buildup. Pressure switches, flow switches

and other safety equipment to prevent unsafe gas buildup is recommended.

10. When the modified air is introduced into the pool or spa water via the existing plumbing, the biocide is produced. Some of the remaining activated atoms either keep minerals dissolved in the water or remove minerals that were previously deposited.

11. This unit is to be installed in accordance with the installation instructions, the applicable plumbing and building codes, the applicable state and local laws and regulations, and the requirements of the Authority Having Jurisdiction.

12. When installing and using this equipment, basic safety precautions should always be followed including the following.

13. WARNING - To reduce the risk of injury, do not permit children to use this product unless they are closely supervised at all times.

14. WARNING - Do not sit or stand on unit.

15. WARNING: UV radiation is dangerous for the eyes and skin. Do not operate the UV-C emitter outside the appliance. (IEC 60335-2-109).

16. If it is intended that replacement of the UV-C emitter can be carried out by the user, the appliance is marked with “Read the instructions” or with symbol ISO 7000-0790 (2004-01). (IEC 60335-2-109).

17. Appliance contains a UV-C emitter. (IEC 60335-2-109).

18. Unintended use of the appliance or damage to the housing may result in the escape of dangerous UV-C radiation. UV-C radiation may, even in little doses, cause harm to the eyes and skin. (IEC 60335-2-109).

19. Appliances that are obviously damaged must not be operated. (IEC 60335-2-109).

20. WARNING - Replacement of the UV-C emitter is NOT allowed by anyone other than Clear Comfort.

21. Appliance must be disconnected from the supply before replacing the UV-C emitter. (IEC 60335-2-109).

22. SAVE THESE INSTRUCTIONS.

ELECTRICAL SAFETY

- Do not service the machine when the power is ON.
- The power supply wire gauge and insulation must meet the temperature and power requirements.
- To avoid personal injury never touch exposed electrical connections or components while the power is ON.
- Do not install/service the Clear Comfort system if you or the machine is standing in water with the power ON.
- Protect the power cord from being walked on or pinched, particularly at plugs and the point where they exit from the system.
- The device must be properly connected to the correct power source (either 60Hz 120V or 230V) using the supplied power cord in accordance with the local electrical code. If possible the unit should be hardwired to the pump circuit and controlled by the pump circuit (rather than hardwiring, an appropriate 120V or 230V receptacle outlet and plug may be used to connect to the pump controlled circuit). If the unit is being wired to standalone AC power (i.e., not through the pump circuit on either 120V or 230V) it should be installed with its own timer circuit and

plugged in through a Ground Fault Circuit Interrupt (GFCI) and the timer should be set to reflect the pool or tub’s hours of operation. Regardless if hardwired or standalone connected, the electrical connection must be made in accordance with the local electrical code.

GROUNDING

The Clear Comfort, Inc. system must be properly grounded. An electrical ground connection to a reliable earth ground is essential for safe operation. Without an electrical ground, all accessible conductive components (including knobs and controls that appear insulated) can render an electrical shock.

GENERAL SAFETY

Use personal protective equipment (steel toe shoes, hearing protection, eye protection) when installing the Clear Comfort system. Follow ladder safety requirements.

CE SAFETY STATEMENT

This appliance is not intended for use by persons (including children) with reduced physical, sensory or mental capabilities, or lack of experience and knowledge, unless they have been given supervision or instruction concerning use of the appliance by a person responsible for their safety. Children should be supervised to ensure that they do not play with the appliance.



FRONT VIEW: CCW25 PORTABLE SPA & SWIM SPA SYSTEM

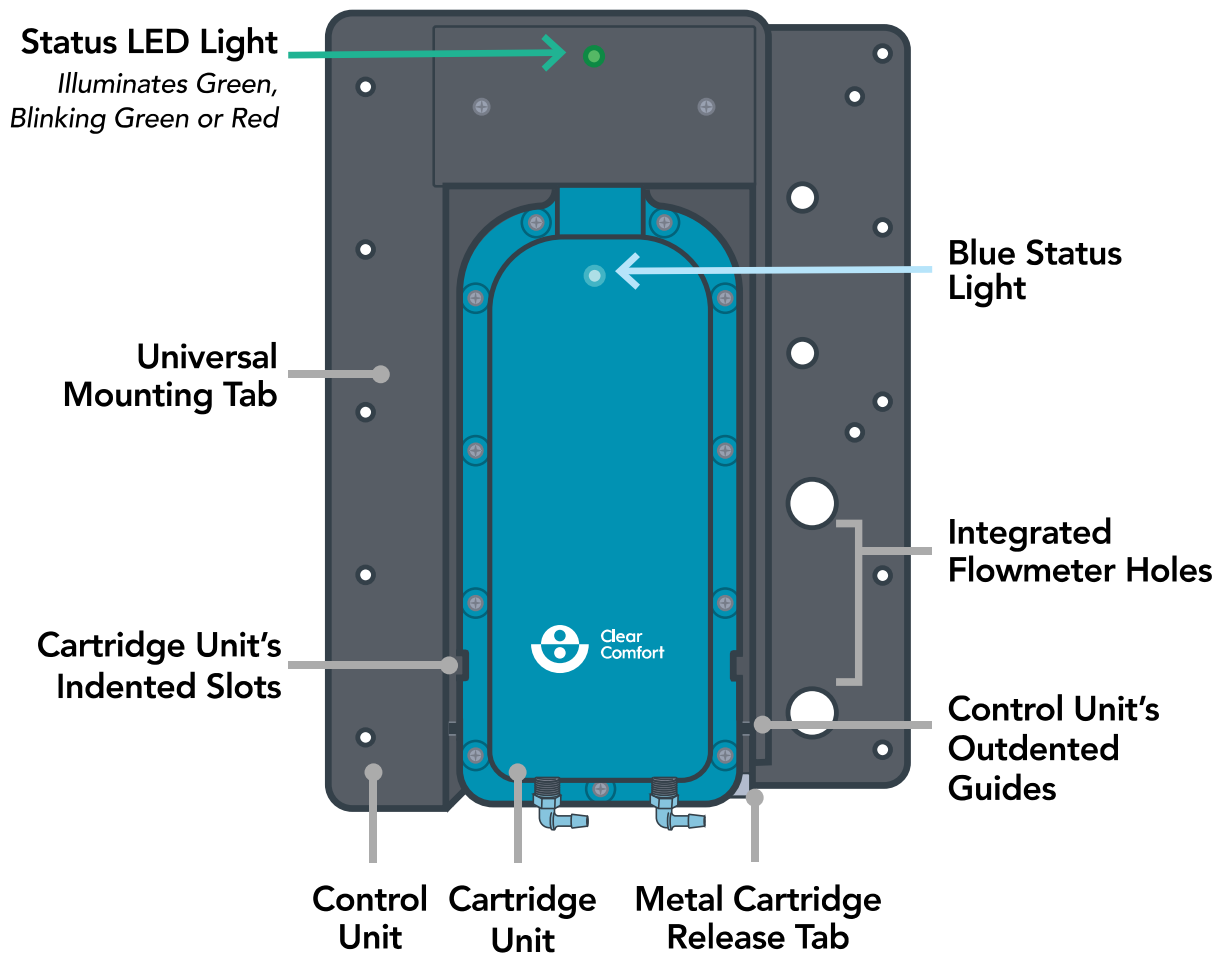

Figure 1: CCW25 System Functions

STATUS LIGHT FUNCTIONALITY

Control Unit Light

 **Green LED Light:** Normal operation.

 **Blinking Green LED Light:** Order new Cartridge.

To order your Cartridge Unit, please visit: clearcomfort.com/cartridge

 **Red LED Light:** Replace Cartridge.

Cartridge Unit Light

 **Blue Light:** Cartridge is receiving power.

STATUS LIGHT FUNCTIONALITY

Please Note: When powering on the system, the Control Unit's Status LED Light cycles twice between Green, Red and finally settles on Green. Then, the Cartridge Unit's Blue Light will turn on.

ADDITIONAL LIGHT FUNCTIONALITY INSTRUCTIONS

Green LED Light: Cartridge life is between 0 - 7,999 hours (good, no action needed).

Blinking Green LED Light: Cartridge life is reaching 8,000 - 9,999 hours (order your Cartridge exchange).

To exchange your Cartridge Unit, please visit: clearcomfort.com/cartridge

Red LED Light: Cartridge life has exceeded 10,000 hours (immediately exchange your Cartridge).

Blue Light: Operation light that should always be illuminated.

NO Blue Light: The Cartridge is not being sensed by the Control Unit.

STANDARD CLEAR COMFORT SYSTEM DESCRIPTION**KEY FEATURES**

This manual describes how to install, operate and maintain the CCW25 Clear Comfort system. Installing your Clear Comfort system is a simple process that can be performed by any professional. This process can be performed in 2 hours or less on most spas and swim spas. After the Clear Comfort system is installed, it is ready to start treating the water immediately. The Clear Comfort system protects spa water (biocide, scale control and corrosion control) without the harsh effects of salt, chlorine, high cyanuric acid or high chlorine levels. The only system maintenance required with a Clear Comfort system is an annual 1-minute cartridge exchange and industry-standard weekly chemical balancing.

ELECTRICAL OPERATING RANGES

- 110/230V
- 50/60Hz
- Less than 1.0 Amp
- Wattage less than 15 Watts

NOTE: CLEAR COMFORT SHOULD ONLY RUN WHEN THE PUMP IS OPERATING

SYSTEM INSTALLATION: SPAS & SWIM SPAS

Prior to installation, determine if the make and model of your spa can be equipped with a supplemental sanitation system. Most spas that are ozone ready or are equipped with a factory ozone can be upgraded with a Clear Comfort AOP system. Spas equipped with dedicated circulation pumps are ideal. Prior to installing, confirm that there is suction at the Venturi injector and bubbles returning to the spa.

PLEASE NOTE: Installation must be performed by your professional service provider.

- **System Capability:** Full-Flow Water Treatment
- **Max. Water Treatment :** 30 GPM (gallons per minute)
- **Typical Application:** Portable Spas & Swim Spas
- **Dimensions:** 11"x5"x5" (not including mounting tabs)
- **Injection Method:** Venturi, Forced Air
- **Operating Voltage:** 110V to 230V (Self-Adjusting)
- **Power Consumption:** Less than 15 Watts
- **Warranty:** 3-Year System Warranty & 1-Year Cartridge Warranty
- **Indoor or Outdoor Spas:** Either is suitable with the CCW25 installed under the spa cabinet. **Note:** The CCW25 is cord connected and designed for under the spa cabinet only.

RECOMMENDED MATERIALS AND TOOLS

- Power Drill & Phillips Bit
- Screwdriver
- Fastening Screws
- Adjustable Wrench
- Cord connected terminals to match your spa manufacturer's requirement for high voltage accessories. For assistance, please consult your spa manufacturer, spa professional or Clear Comfort.

INCLUDED CONTENTS

- CCW25 Unit
- Air Flow Meter
- 4-Pin Y-Harness Connector (AMP Plug)
- L-Barbed Connectors (4)
- Short Air Tubing
- Long Air Tubing With Air Check Valves

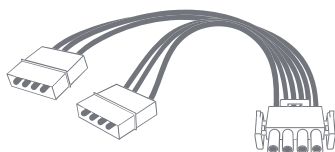

4-PIN Y-HARNESS CONNECTOR
(AMP Plug)

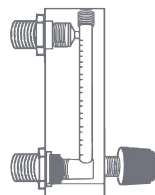

AIR FLOW METER

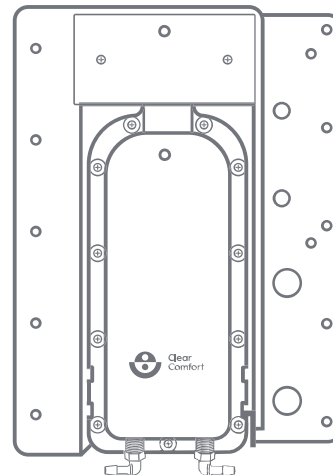

CCW25
Control & Cartridge Units



L-BARBED CONNECTORS
(4 Total, 2 Preinstalled on CCW25 & 2 for Flowmeter)



SHORT AIR TUBING

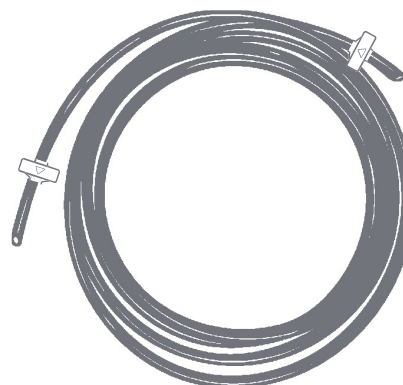

LONG AIR TUBING
With Air Check Valves

Please Note: Content images are not to scale.

AIR PUMP KIT (Optional)

- Air Pump
- Screws (6)
- Locknuts (6)
- Washers (6)

Air Pump Kit Contents

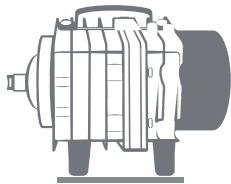

AIR PUMP
120V or 230V

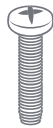

SCREWS
(6)



LOCKNUTS
(6)



WASHERS
(6)

CCW25 SPA & SWIM SPA INSTALLATION
 FULL SYSTEM DIAGRAM: CCW25 INSTALL KIT



IMPORTANT NOTE

We recommend having a professional install your Clear Comfort system. If you need help finding a local installer or have install questions, please contact our live support team at clearcomfort.com/help

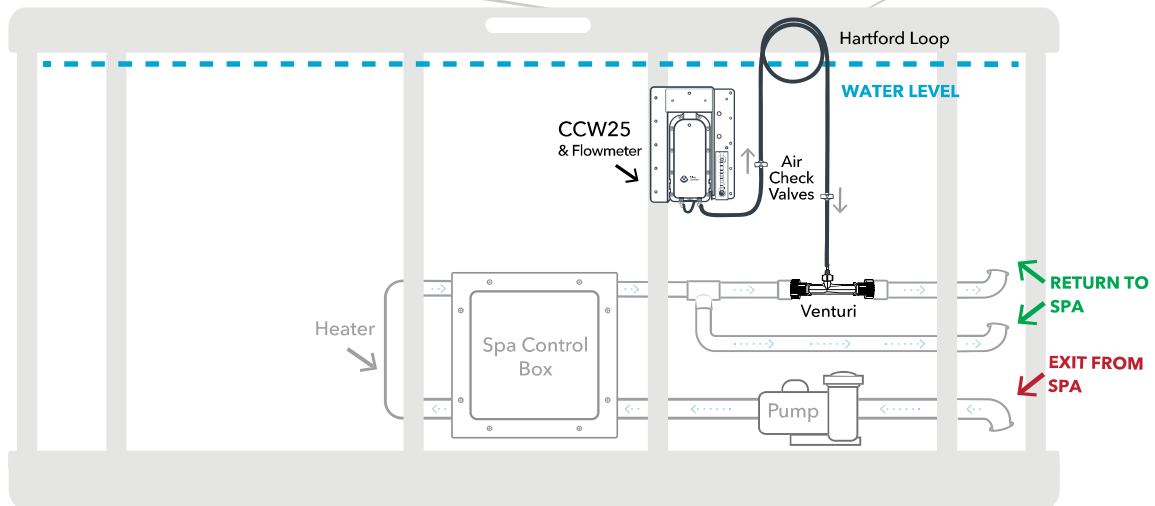
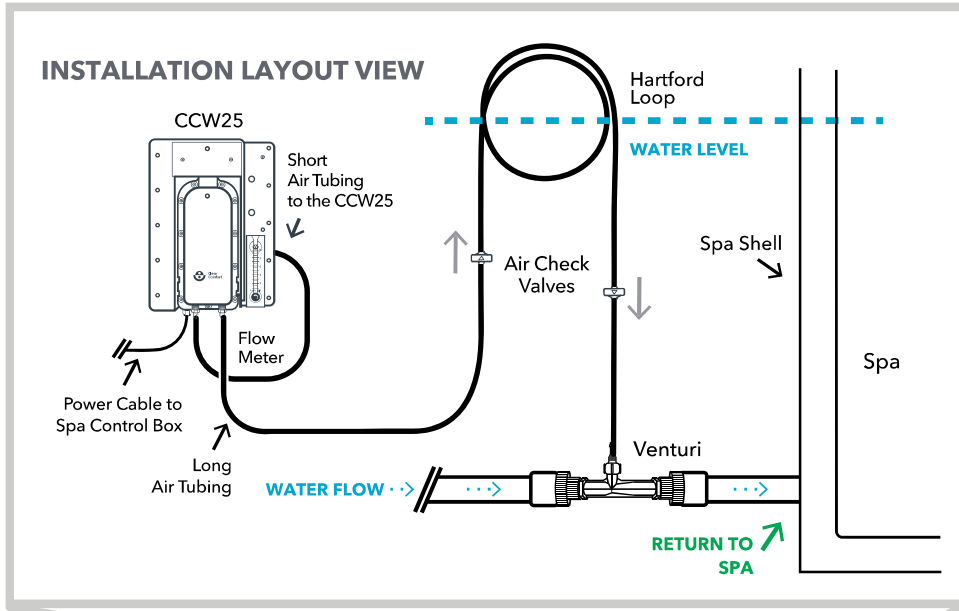

**Air Pump is recommended if the spa can't achieve at least 0.5 LPM of flow through the Venturi.*

Figure 2: Full System Diagram With CCW25 Install Kit

If you have no suction through the existing Venturi injector, please contact Clear Comfort Customer Support.

SYSTEM INSTALLATION: SPAS & SWIM SPAS

1. Prep CCW25 System

- 1 Attach the Air Flow Meter to the CCW25's right mounting tab
- 2 Attach barb fittings to the back of the Air Flow Meter
- 3 Connect the Short Air Tubing from the Air Flow Meter's top barb fitting to the CCW25's left L-barbed connector

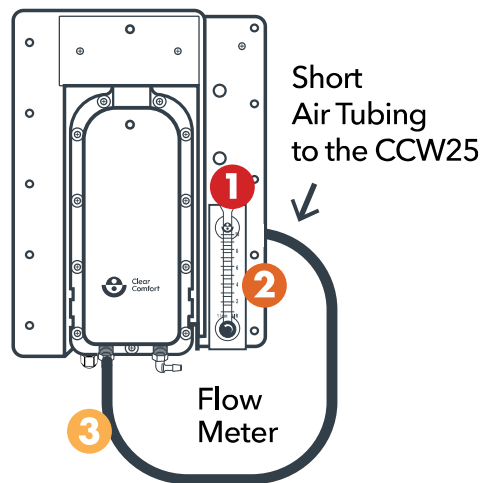

Figure 3: Prep CCW25 System

2. Prep Spa

- Previously used spas, use a spa purge product, drain & refill water
- Balance water chemistry & shock water:
 - Calcium Hardness: 50 - 250 ppm
 - pH: 7.2 - 7.6
 - Alkalinity: 80 - 120 ppm
 - Chlorine: 0.5 - 3 ppm
- **Turn OFF power to the spa**
- Remove the spa's access panel
- Find a location to mount the CCW25

3. Set Up Inside of the Spa

- 1 Secure the CCW25 using the mounting tab with at least 2 screws for mounting support
- 2 Connect Long Air Tubing with the Air Check Valves to the CCW25's right L-barbed connector

Important Note: The Air Check Valves' arrows should both point away from the CCW25 & to the Venturi

- 3 Create a Hartford Loop above water line with the Long Air Tubing
- 4 Connect the Long Air Tubing to the spa's existing Venturi.

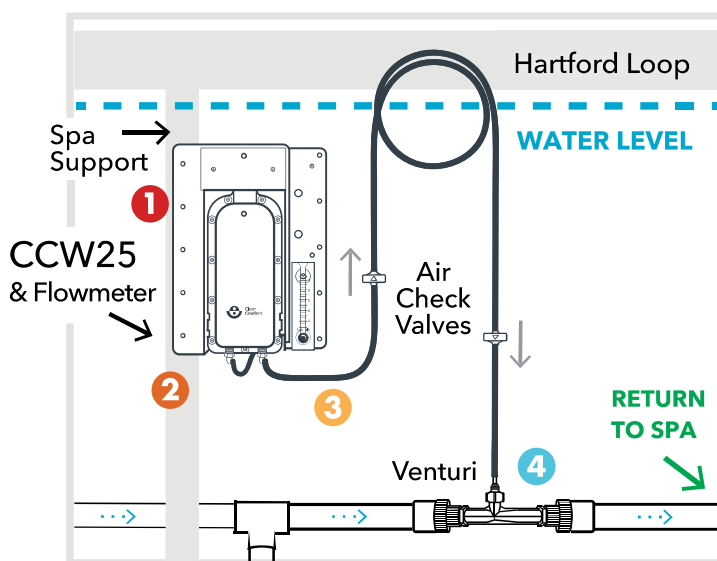

Figure 4: Inside of the Spa

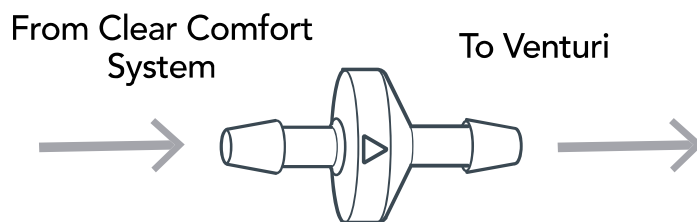

Figure 5: One-Way Air Check Valve in Long Air Tubing

4. Set Up Electrical

1. Remove the spa controller panel cover
2. Properly connect Y-Harness Cables:
 - Connect one Y-Harness Female Cable to the CCW25
 - Connect the other Y-Harness Female Cable to the circulation pump
 - Connect the Y-Harness Male Cable to the circulation pump port
3. Reattach the spa controller panel cover

NOTE: Spa power connections vary by manufacturer. For proper circulation pump power port connection, please refer to the spa’s manual.

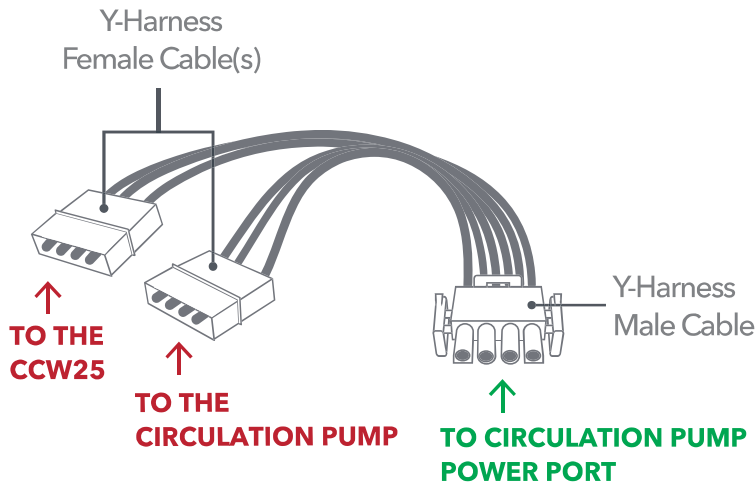

Figure 6: Electrical

5. Adjust Air Flow

1. Turn ON power to the spa
2. Once the water is circulating, adjust the Air Flow Meter’s dial until it reads the recommended 0.5 - 2 LPM
3. Reattach spa’s access panel

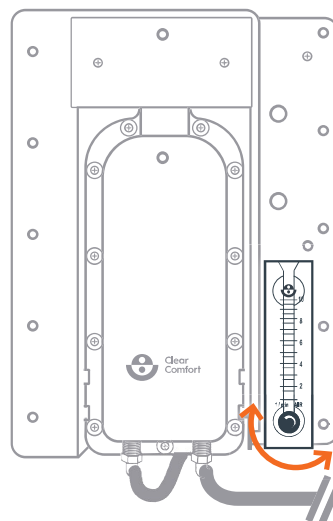

Figure 7: Air Flow Adjustment

BASIC WATER CARE: SPAS

1. Filtration Settings

Clear Comfort should be ON during filtration cycle (the Clear Comfort system's Green Status Light should be ON).



- Preferred filtration time: 24 hours/day (standard for most spas with dedicated circulation pumps)
- Minimum recommended filtration time: 12 hours/day

***NOTE:** Most factory preset times are to set to 2 hours twice a day, consult owners manual to change to 6 hours twice a day.

2. Water Care

- Important! Start with clean, fresh spa water. Spa purge products are recommended. Upon filling with new water, always shock with chlorine to sanitize the tub.

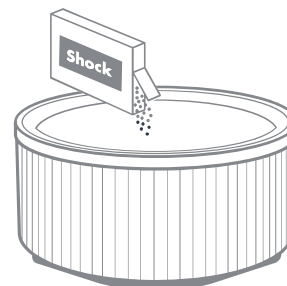

- Clear Comfort's powerful oxidation process can reduce the required residual level & the need for shock treatments.
- Regularly maintain the following water chemical levels at:
 - pH: 7.2 - 7.6
 - Alkalinity: 80 - 120 ppm
 - Calcium Hardness: 50 - 250 ppm
 - Chlorine: 0.5 - 3 ppm
- You may shock your spa after high use periods, if needed.

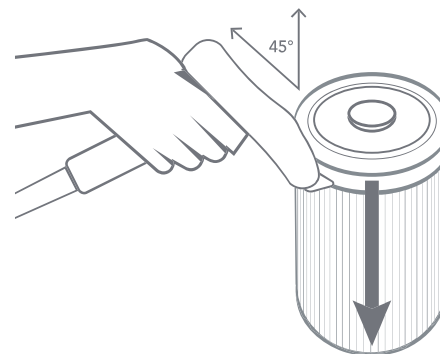

3. Filtration Maintenance

- Maintain and clean filters per your spa manufacturer's recommendations.
- For high use spas cleaning may need to be done at more frequent intervals.

***NOTE:** A dirty filter can have a negative effect on water quality & reduce air flow through the Clear Comfort system.

SYSTEM MAINTENANCE: CARTRIDGE EXCHANGE

HOW TO EXCHANGE YOUR CARTRIDGE

To keep the Clear Comfort system working its best, the Cartridge Unit must be replaced annually. No other system maintenance is required.

 If the Status LED Light is Blinking Green, your Cartridge will expire soon and it's time to order a new replacement Cartridge.

 If the Status LED Light is Red, your Cartridge has **expired & must be exchanged immediately** to protect your water.

To start your exchange and order your new Cartridge replacement, please visit: clearcomfort.com/cartridge

 **IMPORTANT NOTE:** For proper recycling, please return your old Cartridge with the provided label and packaging.

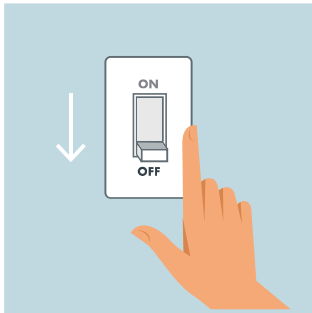

1. Turn OFF and disconnect power to the spa.

NOTE: Never attempt to service unit while it is wet. Ensure all LEDs on the system are OFF.

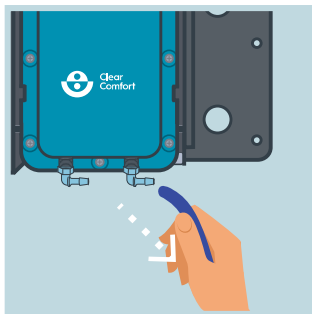

2. Disconnect the Air Tubing from the bottom of the Cartridge Unit.

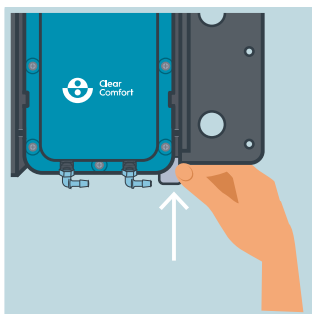

3. Press the Metal Release Tab to release the Cartridge Unit from the Control Unit.



4. Pull the Cartridge Unit down until its top Indented Slots align with the Control Unit's Outdent Guides and remove the Cartridge Unit by lifting it toward you.

NOTE: To see the labeled CCW25's system functions, see page 6.

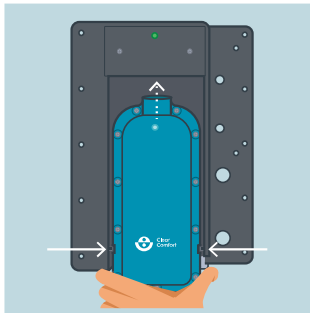

5. To attach the new Cartridge Unit align its top Indented Slots with the Control Unit's Outdent Guides and insert the Cartridge Unit.

IMPORTANT: Save and use the return label and packaging provided with your new Cartridge Unit to send your old Cartridge to Clear Comfort for proper recycling.



6. Push the Cartridge Unit up until the Metal Release Tab clicks back into place.

Tired of Reading?

Scan the QR code to watch our tutorial video, or visit:

clearcomfort.com/video-ccw25-cartridge

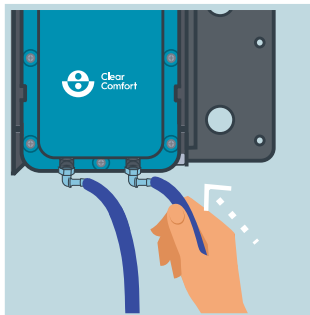

7. Reconnect the Air Tubing to the Cartridge Unit's two (2) barbed fittings.

NOTE: Connect the Short Air Tubing to the left barbed fitting and the Long Air Tubing to the right barbed fitting.

8. Reconnect the spa's power and turn it ON.

NOTE: After the Control Unit Status LED Light's startup sequence, it will illuminate Green. Then, the Cartridge Unit's Blue Status Light will illuminate. For light functionality, see page 7.



9. For sustainability purposes, return your old Cartridge with the shipping label and packaging that was provided with your new replacement Cartridge.

FREQUENTLY ASKED QUESTIONS

- **How is the Clear Comfort AOP system different from traditional water sanitation methods?**

The Clear Comfort system uses a patented Hydroxyl-Based AOP (Advanced Oxidation Process) to create hydroxyl radicals, the most powerful oxidative compounds available for recreational water treatment. Clear Comfort protects pool or spa water (biocide, scale control and corrosion control) without the harsh effects of salt, chlorine, high cyanuric acid or high chlorine levels.
- **How does the Clear Comfort AOP system work?**

Using a unique, proprietary and patented AOP technology, the Clear Comfort system treats ambient air and injects it in the pool or spa plumbing to create high concentrations of hydroxyl radicals. These highly-reactive and short-lived hydroxyl radicals rapidly destroy unwanted contaminants, microorganisms, bacteria, protozoa and viruses, while controlling organic material.
- **How long does it take to install the Clear Comfort AOP system?**

Typically, the install process can be performed in 2 hours or less. After it is installed, it is ready to start treating the water immediately.
- **Where is the Clear Comfort AOP system installed?**

The Clear Comfort system needs to be within 10 feet of the spa Venturi injection site. It can be installed under the spa cabinet for indoor or outdoor spas. The CCW25 is cord connected and designed for under the spa cabinet only, see page 11 for details.
- **Where should the Clear Comfort system be positioned?**

The Clear Comfort system is installed underneath the spa cabinet and positioned as described on page 13.
- **Is the Clear Comfort system affected by temperature?**

No, the Clear Comfort system is design to operate in all conditions your spa is designed to operate.
- **How do I know the Clear Comfort system is working?**

When the Clear Comfort system is ON and operating properly, the Control Unit's Status LED Light will illuminate Green and the Cartridge Unit's Blue Status Light will also illuminate. For proper light functionality, see page 6. If strange light pattern occurs, please contact Clear Comfort.

TROUBLESHOOTING

- **No System Status LED Light on Your Control Unit**
 - Make sure the spa is powered ON.
 - Check the CCW25's Y-Harness Cable is connected to the spa's control board. See Figure 5 for instructions.
- **No Blue Light on Your Cartridge Unit**
 1. Turn the spa's power OFF.
 2. Make sure the Cartridge Unit is installed into the Control Unit.
 3. Ensure the Cartridge Unit is fully connected.
 4. Check that the Cartridge Unit is oriented correctly with its logo facing outward.
 5. Turn the spa's power back ON and ensure the Cartridge Unit's Blue Light is now ON.
- **No Airflow Reading on Flowmeter**
 - Double check your Air Tubing to ensure it isn't kinked.
 - For assistance, please contact Clear Comfort Customer Support.
 - **Please Note:** Optional Air Pump Kit is available, please contact Clear Comfort Customer Support to determine if you require an air pump assistance.
- **Can't Find the Circulation Pump Power Connector on the Spa's Control Board**
 1. Locate and download your spa manufacturer's manual online.
 2. In your spa manufacturer's manual, find where the circulation pump terminal connection is located and note what connection it uses (Flag or AMP connector).
- **Blinking Status LED Light on Your Control Unit**
 - Make sure the Control Unit's Status LED Light illuminates one of the three status colors indicated on page 6. If not, please contact Clear Comfort Customer Support.

Have Questions?

If you need help finding a local installer, installing the system or have questions, please scan the QR code or visit:

clearcomfort.com/help





We're here to help

Have questions? For assistance, contact us:

☎ 303.872.4477

✉ support@clearcomfort.com

🌐 clearcomfort.com/help

For the latest manual
version, scan the QR code or visit:

clearcomfort.com/spa-manual

