

## 1 Install Inlet/Outlet Plumbing to Pump

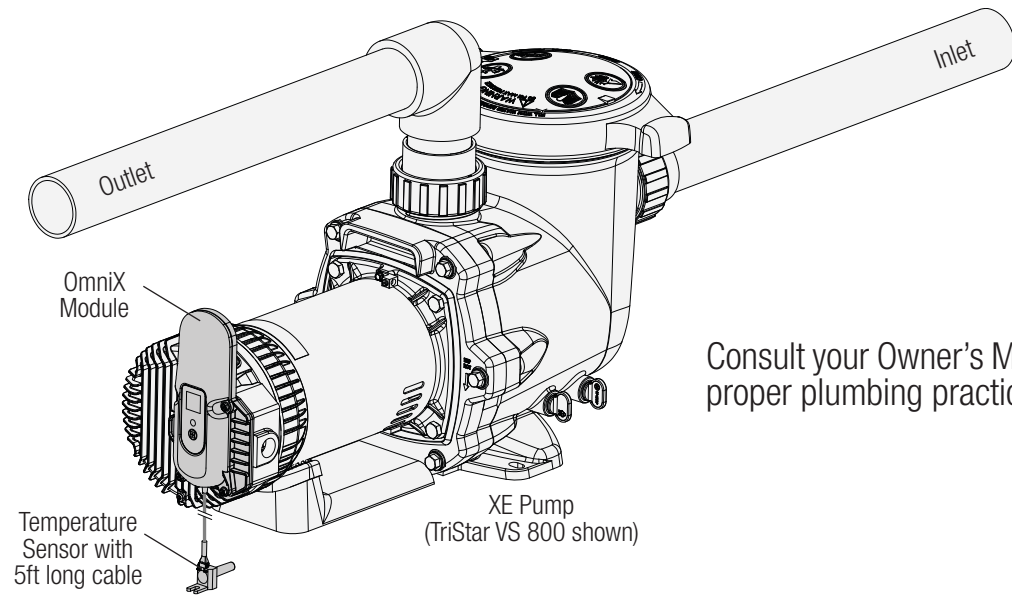

Consult your Owner's Manual for proper plumbing practices

## 3 Install Temperature Sensor into Plumbing

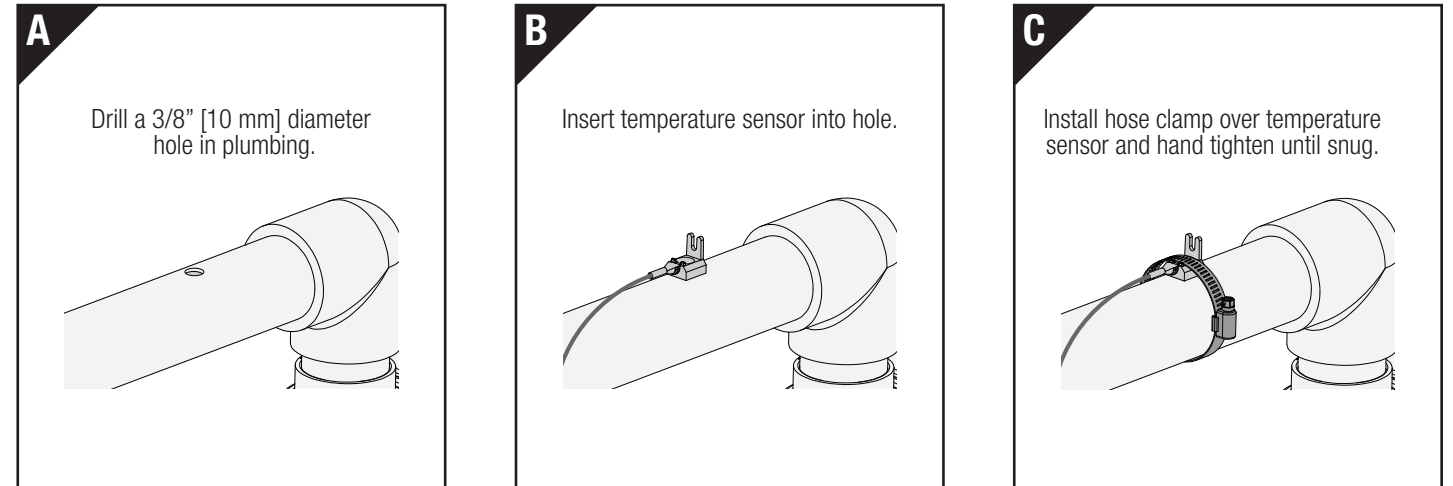

## 2 Electrical Wiring

**WARNING:** All electrical wiring MUST conform to local codes, regulations, and National Electric Code (NEC). Pump MUST be permanently connected to circuit. Connect pump to an appropriately sized/rated branch circuit protector in accordance with local codes, regulations, and the National Electric Code (NEC). Use the circuit breaker as the master On-Off switch.

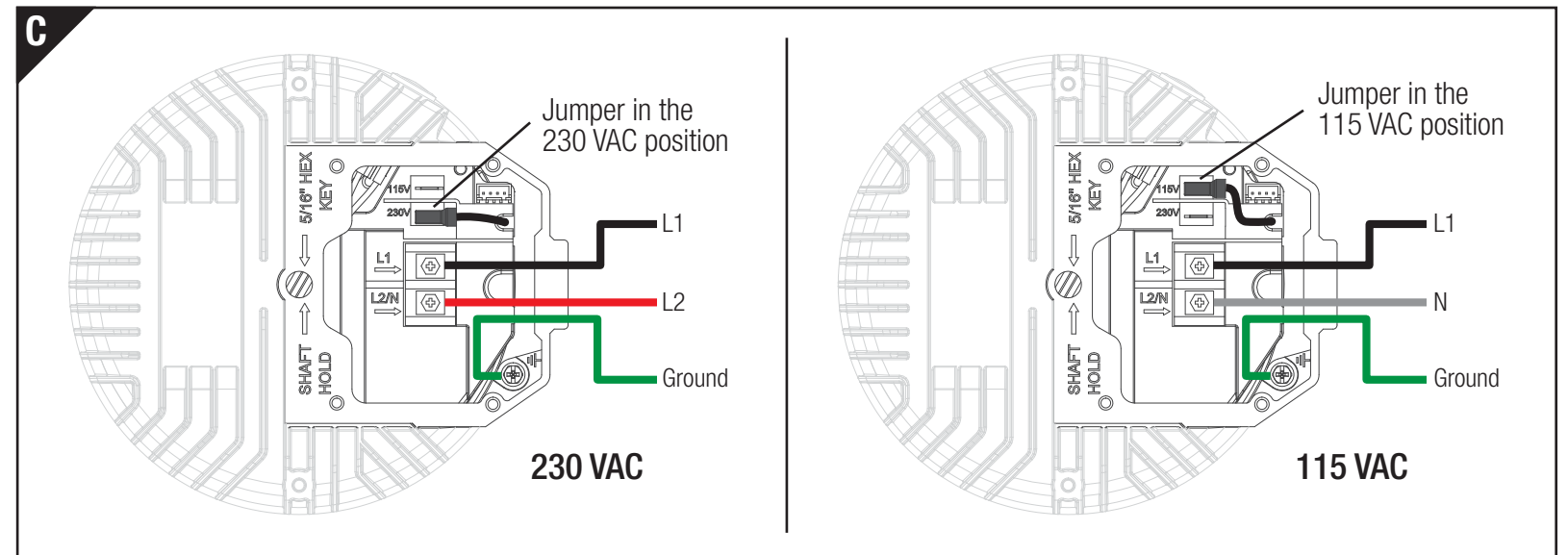
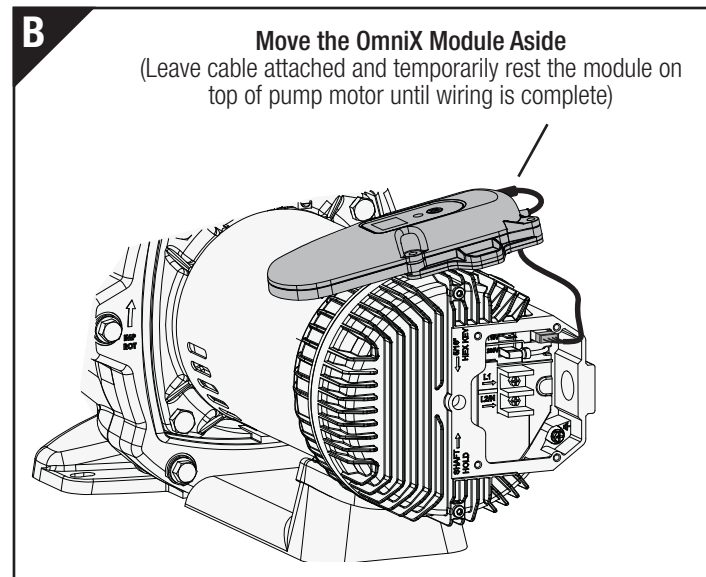
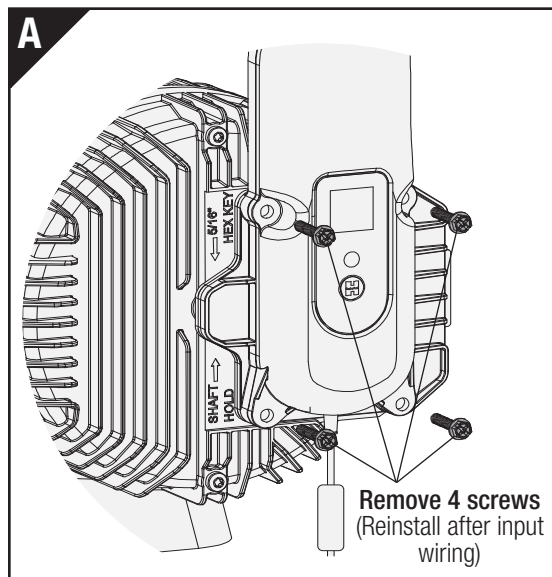

## 4 Download the App, Claim and Configure Your Pump

**A** Before You Begin...

Scan the QR Code below to download the OmniX App

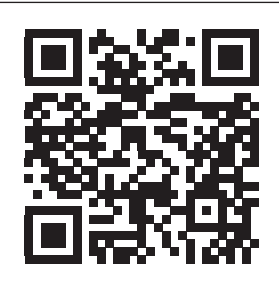

Enable Bluetooth on your Mobile Device

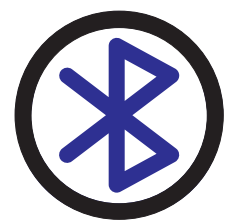

**B** Create an Account or Log in to an Existing Account

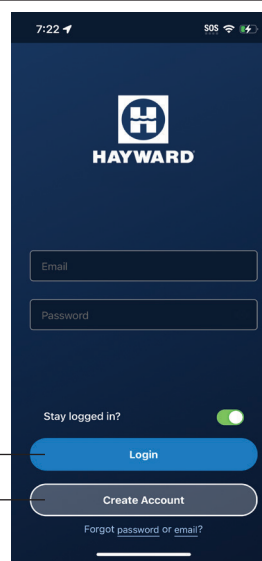
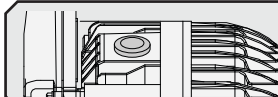
**NOTICE:** When power is first applied to the pump, the pump will turn on for priming. To override priming until the claiming process is complete, press the push button on the pump until the pump stops.

**NOTICE:** For Standalone control and operation of the pump without the use of Bluetooth, consult the Owner's Manual.

**C** Apply Power to the Pump  
(OmniX LED will blink, indicating that it is not yet claimed)

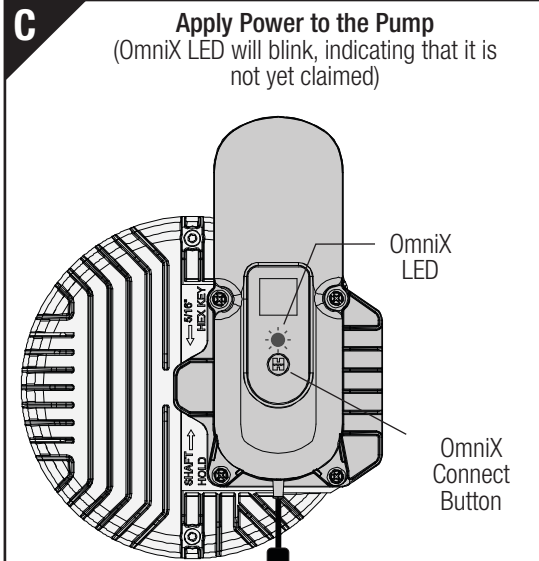

**D** New Accounts: Follow the instructions on the OmniX app to create a new site and claim and configure your pool equipment.

Existing Accounts: Select your site and add new equipment as shown on the right, then follow the instructions on the OmniX app to claim and configure your pool equipment.

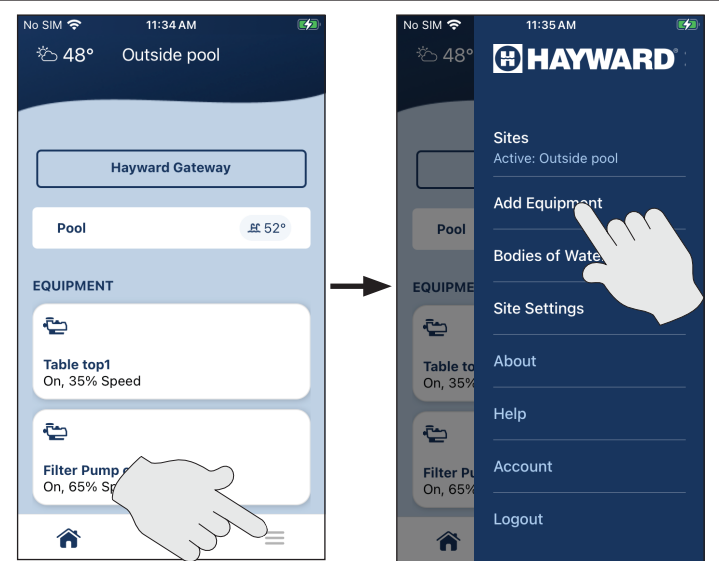

## 5 Mobile App Overview

- A. Home Page**
- OmniX Gateway** - If a Hayward OmniX Gateway (W3GATEWAYX1) is installed, this tile will provide access to Gateway settings. The OmniX Gateway provides internet connectivity for remote app control of OmniX Equipment.
  - Body of Water** - Access settings for the Body of Water.
  - Control Tiles** - Access Equipment Page (see "B").
  - Home Page** - Shortcut to Home page.
  - Messages** - Shortcut to Messages (Alerts and Notifications).
  - Menu** - Access to view and add Equipment, Bodies of Water, and edit Site Settings including:
    - Site Name
    - Site Address
    - Manage Guests
    - Transfer Site
    - Delete Site
- B. Equipment Page**
- Status** - Operating state.
  - Speed Slider** - Custom speed control slider.
  - Pump Speeds** - Preset speed selector.
  - Settings** - Pump Diagnostics, History and Equipment Settings (see "C").
  - Countdown Timer** - Custom countdown timers.
  - Schedules** - Create, delete and modify schedules.
  - Network** - Status of method and quality of equipment network.
  - Equipment Toggle** - Enable and disable pump operation.
  - Schedule Toggle** - Enable/Disable schedules.

- C. Settings Page**
- Equipment Info** - Detailed pump information.
  - Diagnostics** - Pump operating parameters.
  - History** - Displays past diagnostic information.
  - Equipment Settings** - Modify pump configuration settings (see "D").
- D. Equipment Settings Page**
- Pump Name** - Edit pump name.
  - Pump Type** - Change pump type (filter, accessory, booster).
  - Min/Max Speed** - Edit minimum and maximum allowed speeds for the pump.
  - Speed Presets** - Edit Low, Medium, and High preset speeds.
  - Priming** - Edit priming configuration.
  - Freeze Protect** - Edit freeze protect configuration.
  - Temperature Sensor Adjustment** - Add an offset to measured reading.

**A** Home Page

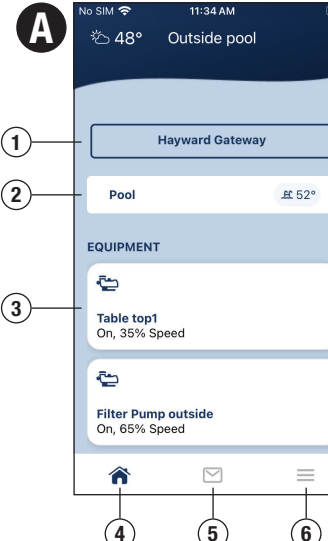

**B** Equipment Page

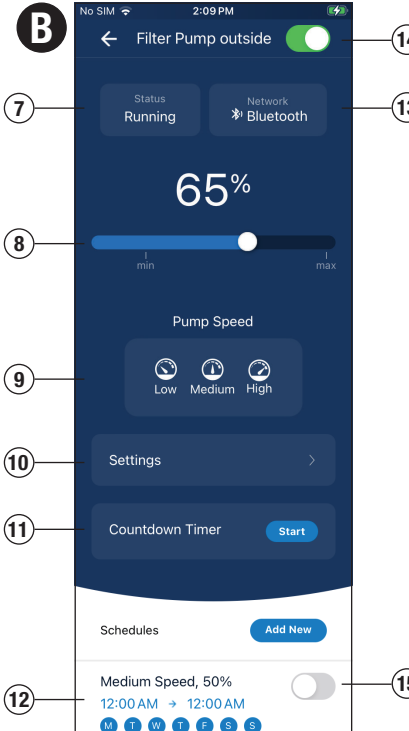

**C** Settings Page

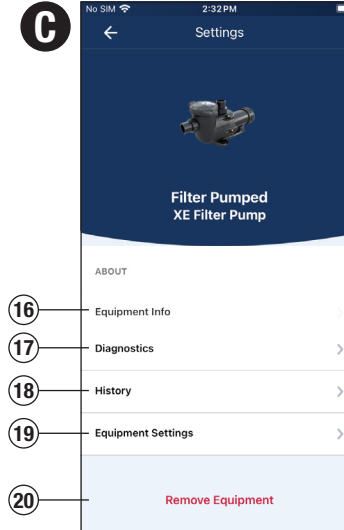

**D** Equipment Settings Page

